

32" FLAT PANEL LCD WALL MOUNTING DETAIL

SYMBOL 

THLC200W with SAMSUNG LN32C45B

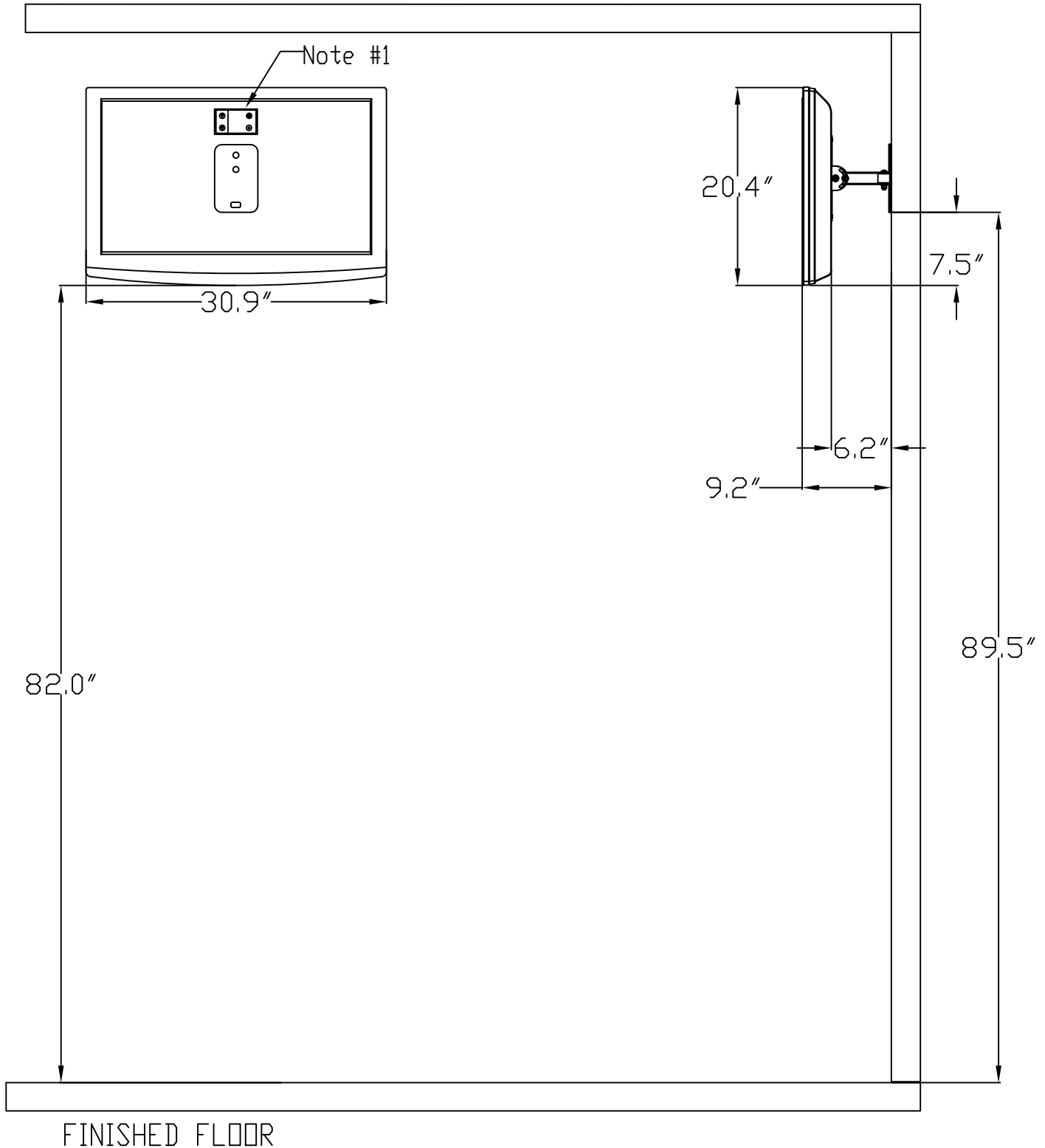

NOTE #1) TV OUTLET REQUIRES A STANDARD THREE GANG BACKBOX WITH A LOW PARTITION AND A 110V DUPLEX POWER OUTLET.